

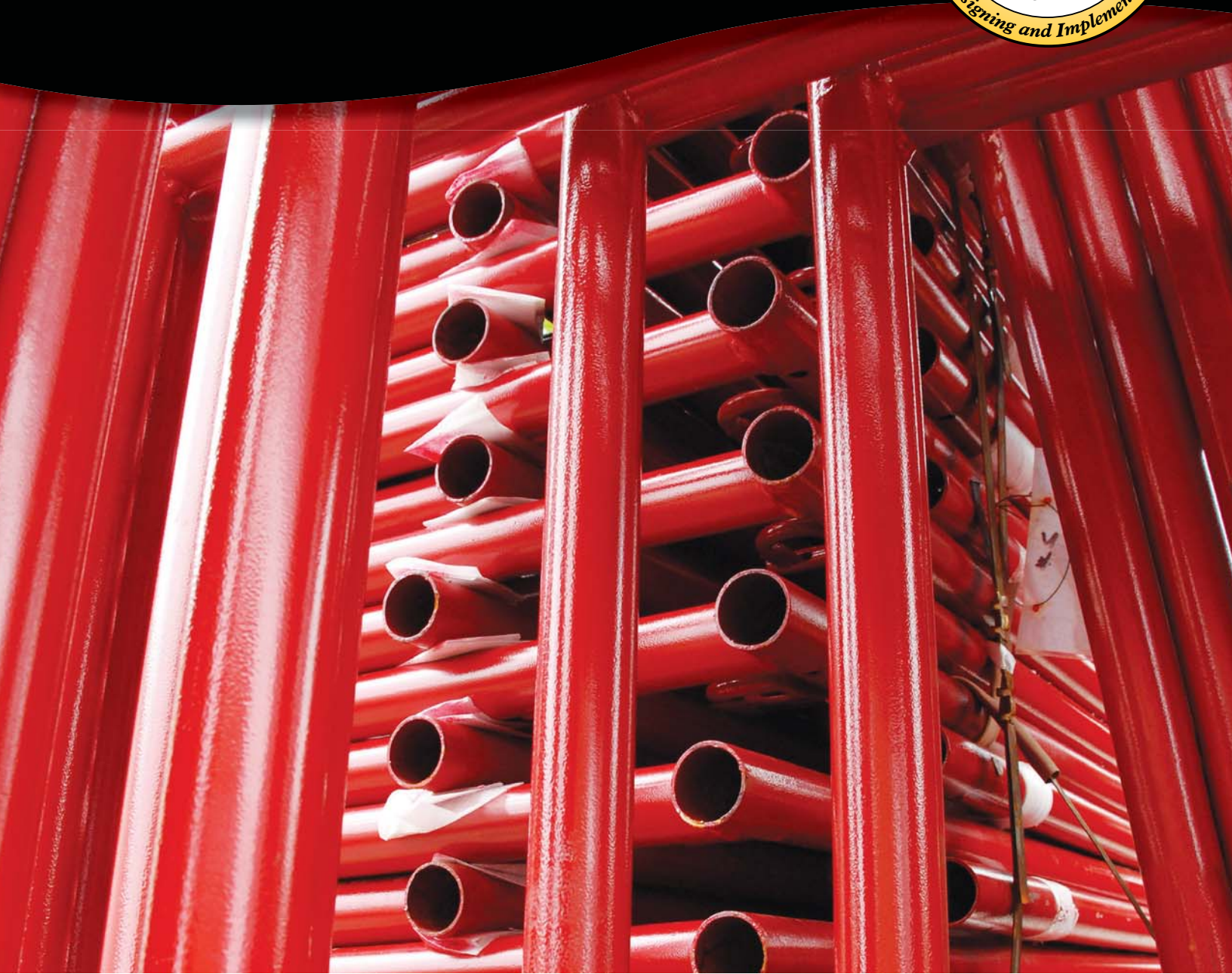

The Leader in Scaffold Services



FRAME SCAFFOLDING

1-800-247-9206

www.superiorscaffold.com

Superior quality, standards, safety and design for over 50 years.

Superior Scaffold is designed and manufactured to meet the rigorous standards contractors and builders demand. We have a huge assortment of Mason, Walk-Thru, Ladder, and Narrow frames suitable for any job.

Superior Scaffold has the strongest interior members utilizing 1.25" O.D. tubing instead of 1" O.D., which is commonly used on lesser frames. Our frames outpace the industry with an exterior leg tubing that utilizes 1.625" O.D. quality, corrosion resistant, powder coated steel. Ours is Superior – bigger, better, stronger.



Superior Frame Scaffold Faster, better, stronger.

Superior is a family owned, customer-centric business that can respond faster, better, and more efficiently than any other scaffold company in the market.

We've been providing the best service in the scaffolding industry for over 50 years.

We built our reputation on superior customer service and products. Meeting and exceeding client's needs has always been priority number one.

Superior has the equipment and personnel necessary to handle ANY job.



Table of Contents

Rolling Tower Scaffold	2	Hook on Platforms & LVL Wood Plank	9
Standard Mason Frames	3	Putlogs & Putlog Accessories	10
Standard Walk-Thru & Canopy Frames	4	Accessways & Wheels	10
Ladder Frames & Narrow Walk-Thru Frames	5	Fast Tubes & Misc. Accessories	11
Cross Braces, Guard Rails, Panels & Guard Post	6	Decorator/Utility Scaffold & Accessories	12
Brackets, Braces & Spacers	7	Netting & Chutes	13
Clips, Pins, Ladders & Leveling Jacks	8	Safety Information	14
Base Plates & Casters	8		

Rolling Tower Scaffold

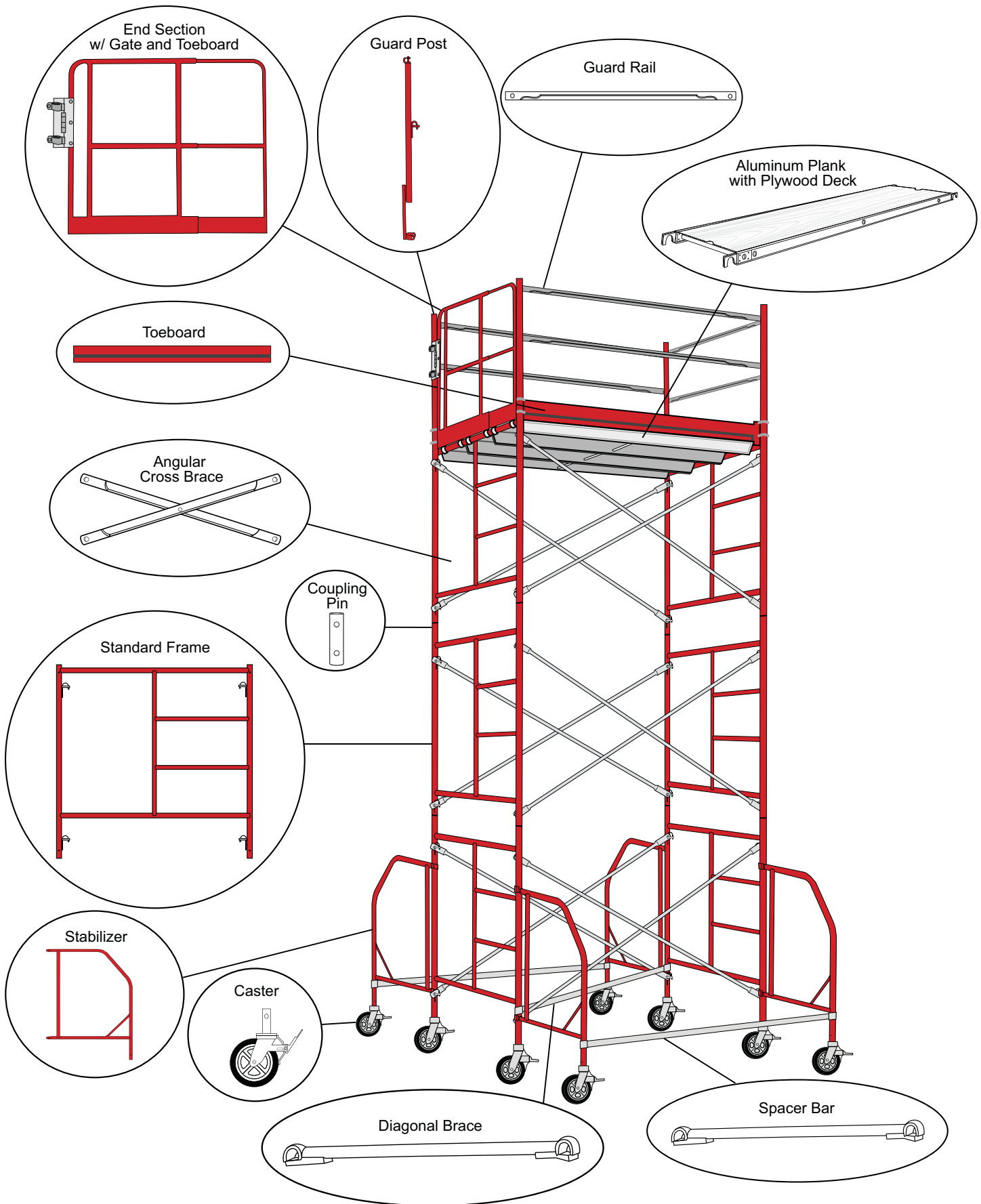

- Questions? Contact us at 1-800-247-9206
- We offer a wide variety of custom solutions for any project.
- Need more information? Visit our website at www.superiorscaffold.com

Standard Mason Frames

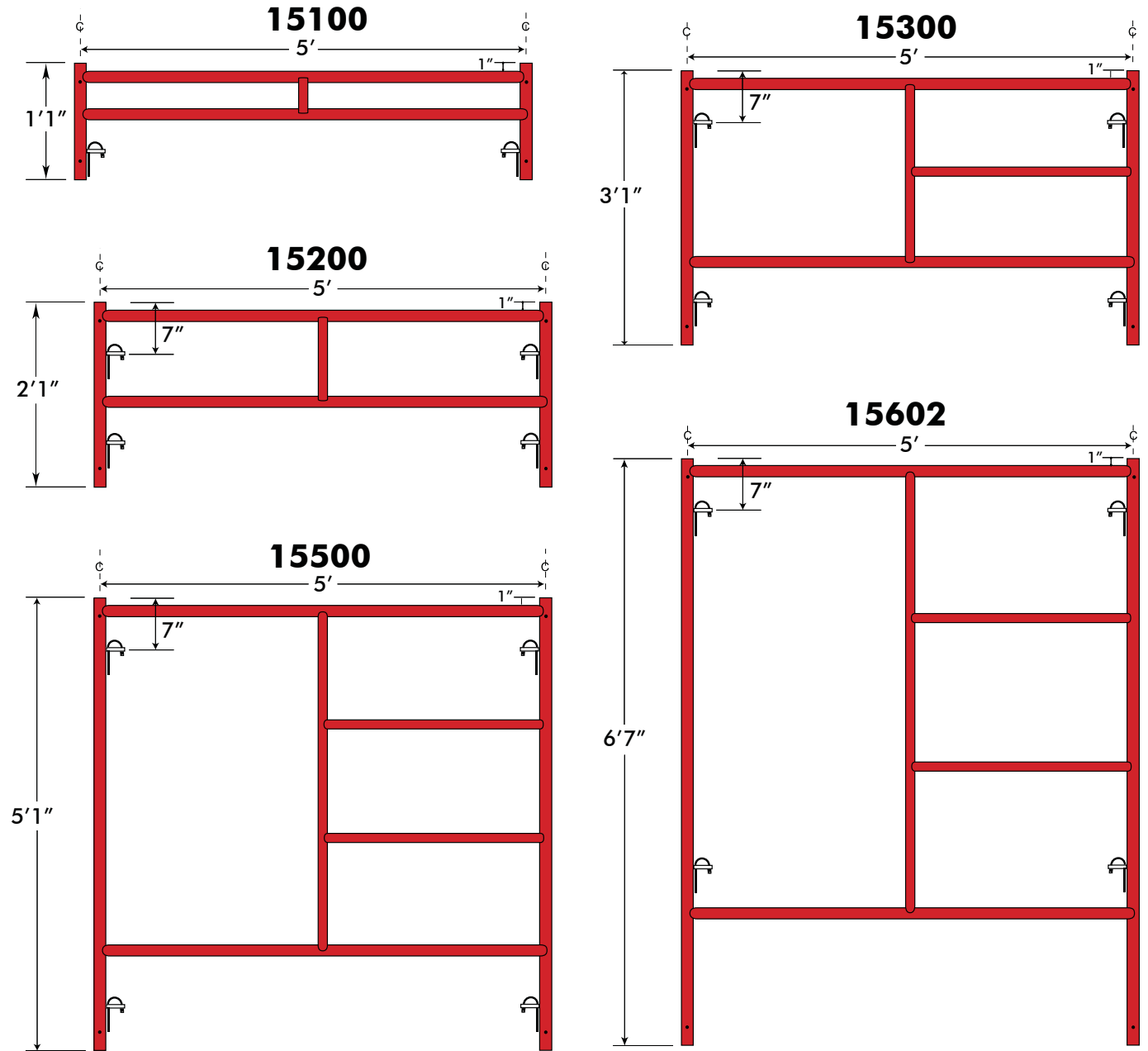

Standard Mason Frames

Part No.	Description	Lock Spacing	Weight
15100	5' W X 1'1" H Standard End Frame - One Lock	-	18.7 lbs
15200	5' W X 2'1" H Standard End Frame	1'	25.4 lbs
15300	5' W X 3'1" H Standard End Frame	2'	32.1 lbs
15500	5' W X 5'1" H Standard End Frame	4'	42.4 lbs
15602	5' W X 6'7" H Standard End Frame	4'	48.2 lbs

- Superior Scaffold frames are WACO™ compatible.
- Top ledger is always 1" below frame height.
- 12" rung spacing is available for special order.

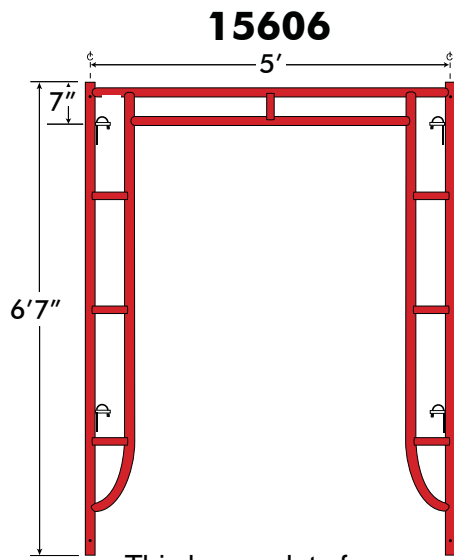

This heavy-duty frame (aka J-frame) has the widest walk-thru.

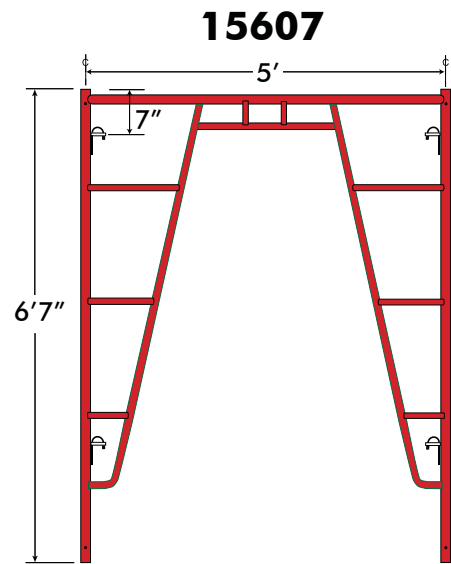

This is the strongest design of our walk-thru frames.

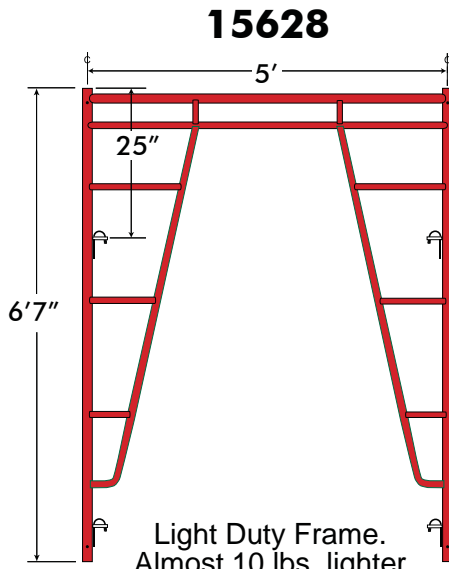

Light Duty Frame. Almost 10 lbs. lighter than the 15606.

Standard Walk-Thru Frames

Part No.	Description	Lock Spacing	Weight
15606	5' W X 6'7" H	4'	53.0 lbs
15607	5' W X 6'7" H	4'	54.6 lbs
15628	5' W X 6'7" H	4'	43.5 lbs

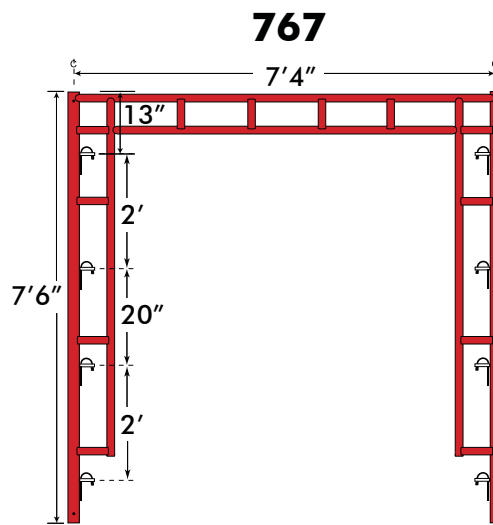

Canopy Frame

Part No.	Description	Lock Spacing	Weight
767	7'4" W X 7'6" H Canopy Frame	2' x 2'	105.8 lbs

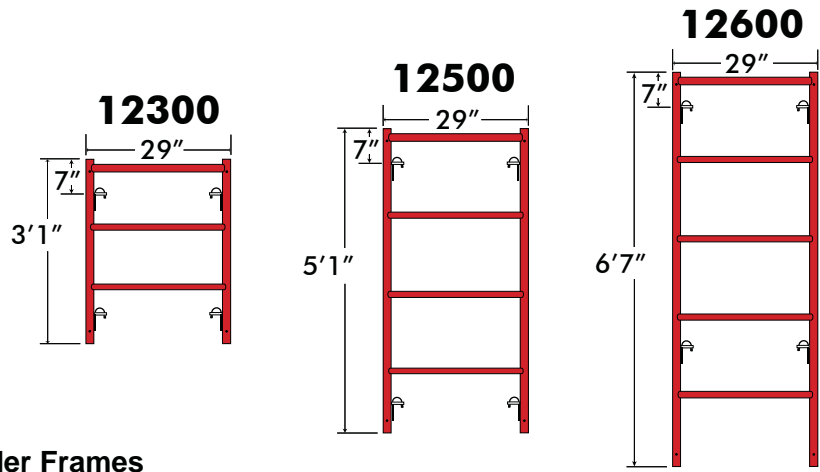

Ladder Frames

Part No.	Description	Lock Spacing	Weight
12300	29" W X 3'1" H Ladder Frame	2'	21.0 lbs
12500	29" W X 5'1" H Ladder Frame	4'	29.2 lbs
12600	29" W X 6'7" H Ladder Frame	4'	36.8 lbs

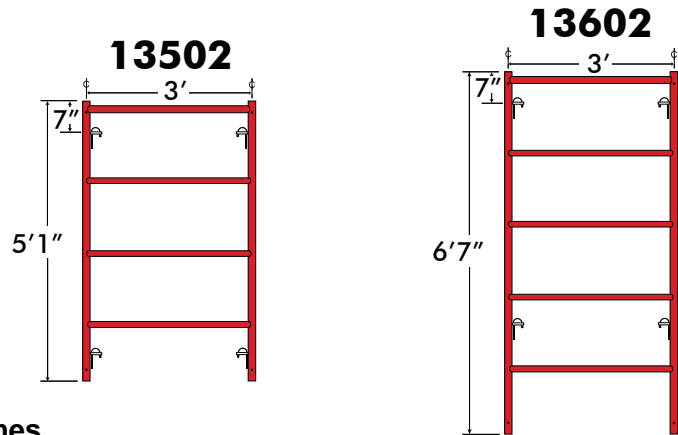

Narrow Frames

Part No.	Description	Lock Spacing	Weight
13300	3' W X 3'1" H Narrow Frame	2'	21.4 lbs
13402	3' W X 4'1" H Narrow Frame	3'	30.0 lbs
13502	3' W X 5'1" H Narrow Frame	4'	32.1 lbs
13602	3' W X 6'7" H Narrow Frame	4'	40.6 lbs

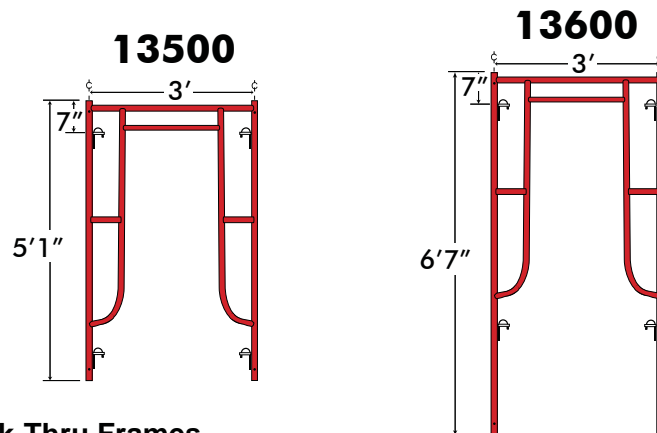

Narrow Walk-Thru Frames

Part No.	Description	Lock Spacing	Weight
13500	3' W X 5'1" H Narrow Walk-Thru Frame	4'	34.9 lbs
13600	3' W X 6'7" H Narrow Walk-Thru Frame	4'	40.1 lbs

Single Hole Angular Cross Brace

Part No.	Lock Spacing	Span	Weight	"X"
25205	1'	5'	10.00 lbs	61 1/4"
25206	1'	6'	11.60 lbs	73"
25207	1'	7'	13.50 lbs	84 7/8"
25305	2'	5'	10.20 lbs	64 5/8"
25306	2'	6'	12.00 lbs	75 7/8"
25307	2'	7'	15.90 lbs	87 3/8"
25308	2'	8'	17.11 lbs	99"

Double Hole Angular Cross Brace

Part No.	Lock Spacing	Span	Weight	"X"
24404	3' & 4'	4'	13.23 lbs	67 3/4"
24405	3' & 4'	5'	14.33 lbs	76 7/8"
24406	3' & 4'	6'	15.43 lbs	86 1/2"
24407	3' & 4'	7'	17.20 lbs	96 3/4"
24408	3' & 4'	8'	18.74 lbs	107 3/8"
24410	3' & 4'	10'	22.05 lbs	129 1/4"

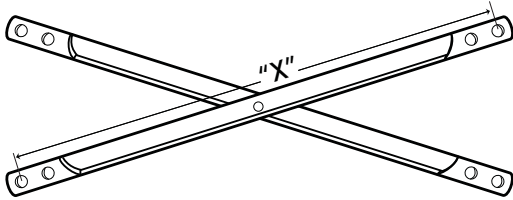
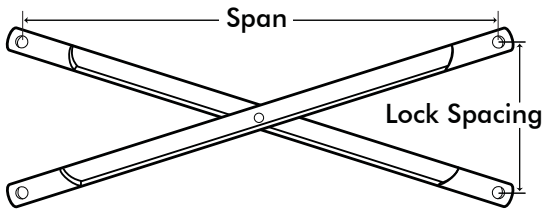

Guard Rails

Part No.	Description	Weight
32303	Guard Rail 3' Long	3.1 lbs
32505	Guard Rail 5' Long	4.9 lbs
32606	Guard Rail 6' Long	5.8 lbs
32707	Guard Rail 7' Long	6.3 lbs
32808	Guard Rail 8' Long	6.6 lbs
32710	Guard Rail 10' Long	10.5 lbs

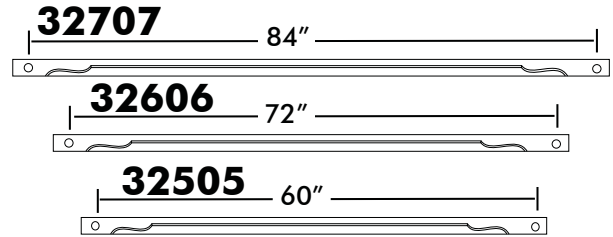

32504

32777

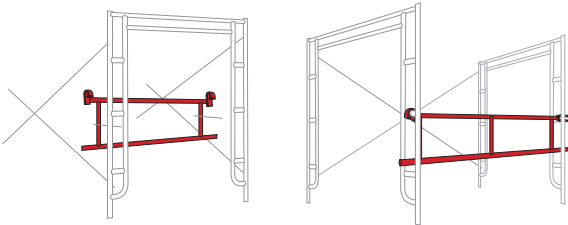

GRGTB

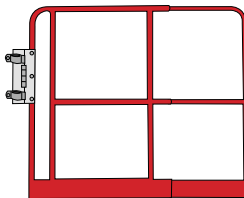

Guard Rail Panels

Part No.	Description	Weight
32504	5' Hanging Guard Rail Endrail	19.8 lbs
32666	Guard Rail Panel 6' Long	13.0 lbs
32777	Guard Rail Panel 7' Long	15.2 lbs
32888	Guard Rail Panel 8' Long	16.9 lbs
GRGADJ	Guard Rail Gate Adj.	30.5 lbs
GRGTB	Guard Rail Gate (Adj. w/Toeboard)	38.0 lbs

Guard Post

Part No.	Description	Weight
320	Standard Guard Post	9.3 lbs

320

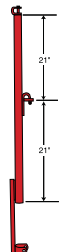

- OSHA Regulation 1910.28 (f)(15)
"Guardrails...and toeboards, shall be installed at all open sides on all scaffolds more than 10 feet above the ground or floor."

Side Brackets

Part No.	Description	Weight
33200	23.5" Side Bracket	9.9 lbs
33212	12" Side Bracket	7.2 lbs
33220	20" Side Bracket (2 Board)	9.3 lbs

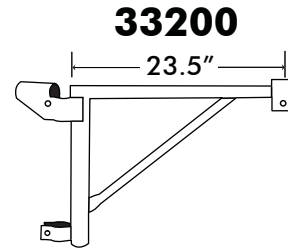

Specialty Brackets

Part No.	Description	Weight
33000	21.5" Side & End Bracket	13.7 lbs
33100	31.5" Side & End Bracket	18.9 lbs
33110	31" Side Bracket (3 Board)	19.2 lbs
33141	41" Side Bracket (4 Board)	27.6 lbs

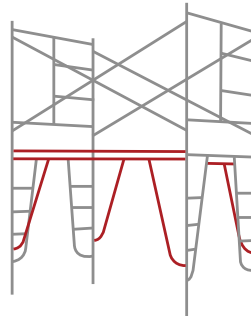
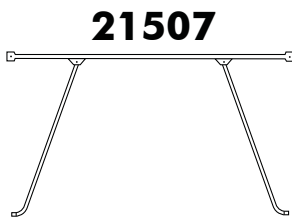

Straddle Braces

Part No.	Description	Weight
21507	7' Straddle Brace	20.0 lbs
21508	8' Straddle Brace	21.4 lbs
21510	10' Straddle Brace	32.0 lbs

Diagonal Braces

Part No.	Description	Weight
26205	Diagonal for Ladder Frames - 5' Bay Space	11.2 lbs
26207	Diagonal for Ladder Frames - 7' Bay Space	12.9 lbs
26208	Diagonal for Ladder Frames - 8' Bay Space	16.4 lbs
26210	Diagonal for Ladder Frames - 10' Bay Space	17.4 lbs
26307	Diagonal for Narrow Frames - 7' Bay Space	13.1 lbs
26308	Diagonal for Narrow Frames - 8' Bay Space	16.7 lbs
26310	Diagonal for Narrow Frames - 10' Bay Space	17.8 lbs
26505	Diagonal for Standard Frames - 5' Bay Space	12.5 lbs
26507	Diagonal for Standard Frames - 7' Bay Space	14.7 lbs
26508	Diagonal for Standard Frames - 8' Bay Space	16.4 lbs
26510	Diagonal for Standard Frames - 10' Bay Space	18.5 lbs

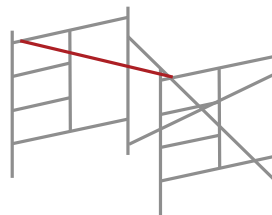
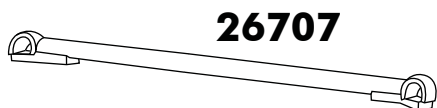
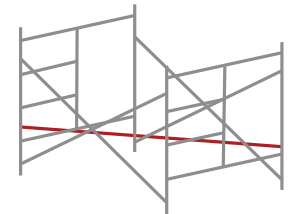
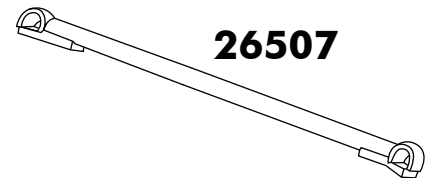

Horizontal Spacer Bars

Part No.	Description	Weight
26705	Spacer Bar 5' Span	10.0 lbs
26707	Spacer Bar 7' Span	12.3 lbs
26708	Spacer Bar 8' Span	15.0 lbs
26710	Spacer Bar 10' Span	16.7 lbs

Clips & Pins

Part No.	Description	Weight
200	Toggle Pin	25.4 lbs
202	Clamp-on Cross Brace Attachment Point	32.1 lbs
205	Coupling Pin	42.4 lbs
206	Spring Retainer Clip for 205	48.2 lbs

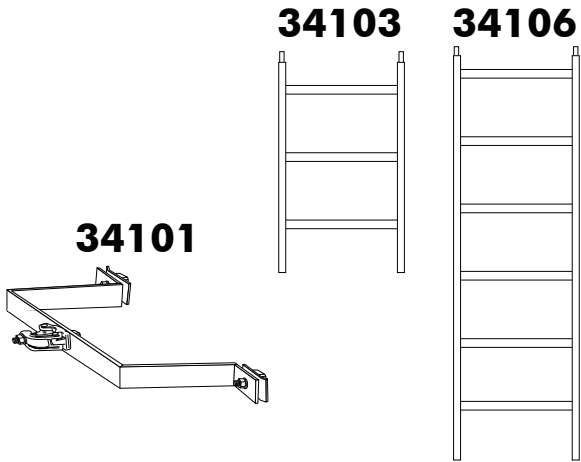
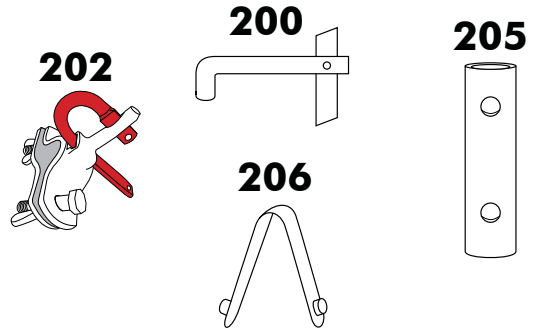

Ladders

Part No.	Description	Weight
34101	Ladder Bracket	5.5 lbs
34103	3' H Ladder	9.5 lbs
34106	6' H Ladder	18.0 lbs

Leveling Jacks

Part No.	Description	Weight
30518	With Base Plate – 21" long, 15" Screw Adj.	11.5 lbs
306	Socket type for use with caster or base plate 26" long, 15" Screw Adj.	11.0 lbs
30988	Jack w/8" x 8" U-Head – 21" long, 15" Screw Adj.	12.0 lbs

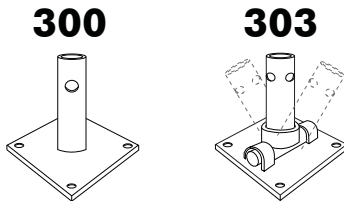
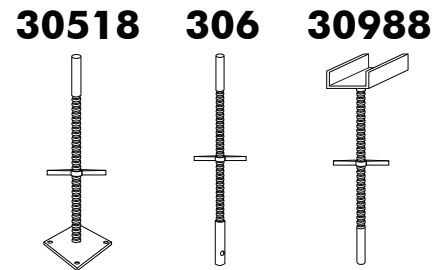

Base Plates

Part No.	Description	Weight
300	5" X 5" Fixed Base Plate	1.8 lbs
303	5" X 5" Swivel Base Plate	2.6 lbs

Casters

Part No.	Description	Weight
318	8" Heavy Duty Caster	11.0 lbs
31812	12" Heavy Duty Urethane Caster	26.0 lbs

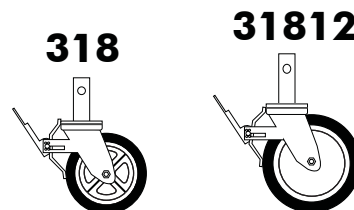

530719

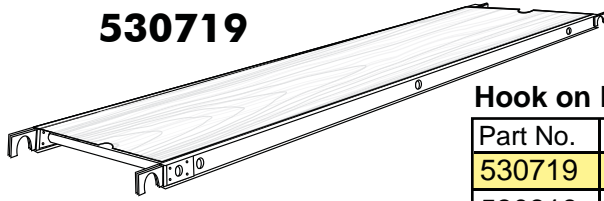

Hook on Platform - Aluminum w/ Plywood Deck

Part No.	Description	Weight
530719	7' L X 19" W Aluminum Platform w/Plywood Deck	27.0 lbs
530819	8' L X 19" W Aluminum Platform w/Plywood Deck	30.0 lbs
531019	10' L X 19" W Aluminum Platform w/Plywood Deck	39.0 lbs
530724	7' L X 24" W Aluminum Platform w/Plywood Deck	32.0 lbs
530824	8' L X 24" W Aluminum Platform w/Plywood Deck	43.0 lbs
531024	10' L X 24" W Aluminum Platform w/Plywood Deck	53.0 lbs

550719

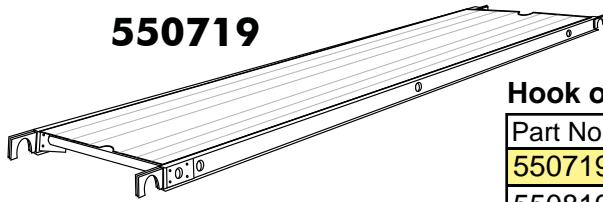

Hook on Platform - All Aluminum

Part No.	Description	Weight
550719	7' L x 19" W All Aluminum Platform	25.0 lbs
550819	8' L x 19" W All Aluminum Platform	34.0 lbs
551019	10' L x 19" W All Aluminum Platform	40.0 lbs

ML08

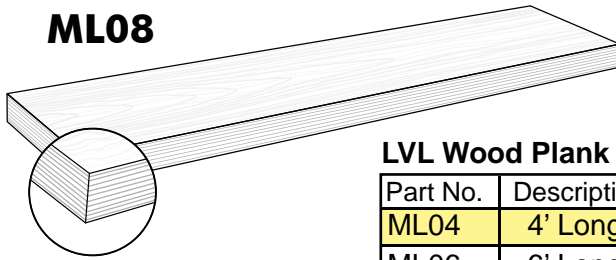

Features include:

- Individually proof tested
- Tough and long lasting
- Lightweight and versatile
- 100% renewable wood resources

LVL Wood Plank (OSHA Grade Laminated Scaffold Plank)

Part No.	Description	Weight
ML04	4' Long Laminated Plank	16.8 lbs
ML06	6' Long Laminated Plank	25.2 lbs
ML08	8' Long Laminated Plank	33.6 lbs
ML10	10' Long Laminated Plank	42.0 lbs
ML16	16' Long Laminated Plank	67.2 lbs
WB02	Wood Block	4.2 lbs

Superior only uses laminated scaffold plank (or LVL – Laminated Veneer Lumber) for strength and durability. Each length of plank is 9.5" wide X 1.5" thick.

Laminated Veneer Lumber (LVL) is a super strong yet lightweight scaffold plank.

Simple Span Loading Condition

Load Condition	Span*
50 psf	10' 6"
75 psf	9' 0"
1-Person	10' 6"
2-Person	8' 6"
3-Person	6' 0"

OSHA, Scaffold Specifications – 1926 Subpart L, Appendix A.
* - 9.5" Width x Standard 1.5" Nominal Thickness

- Spans are from center to center of scaffold supports.
- The "Person" load is defined in ANSI A10.8 as a 200-pound person with 50 pounds of equipment.

Putlogs

Part No.	Description	Weight
36008	8' Long Putlog	25.6 lbs
36010	10' Long Putlog	32.0 lbs
36012	12' Long Putlog	38.0 lbs
36016	16' Long Putlog	51.2 lbs
36116	16' Long Putlog (Trussed)	62.7 lbs
36122	22' Long Putlog (Trussed)	95.6 lbs

Install at your own risk.

If installed improperly they can be extremely dangerous.

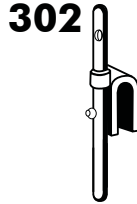
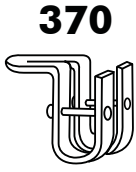
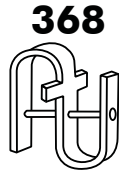
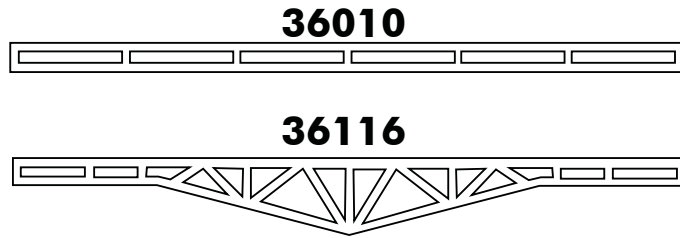

Putlog Accessories

Part No.	Description	Weight
368	Angle "S" type Hanger	5.6 lbs
370	Regular Angle-type Hanger	5.9 lbs
301	Direct Saddle Connector	2.8 lbs
302	Offset Saddle Connector	5.1 lbs

Internal Accessways

Part No.	Description	Weight
34507	Stairway Unit - 7 Step (for 5' High Frame) Used on 15500 – 5' End Frames	81.7 lbs
34517	External Hand Rail for 7 Step Unit	29.6 lbs
34607	Stairway Unit - 9 Step (for 6'7" High Frame) *Used on 15602, 15606, 15607 and 15628 Frames	94.9 lbs
34617	External Hand Rail for 9 Step Unit	32.2 lbs
34277	Internal Hand Rail for 7 or 9 Step Unit Fits both accessways	16.9 lbs

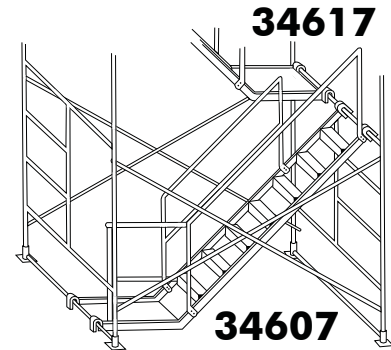

Well Wheels & Well Wheel Accessories

Part No.	Description	Weight
353	Hoist Head Only	6.6 lbs
354	Hoist Standard	27.3 lbs
355	Hoist Standard & Head	33.9 lbs
Wheel	Well Wheel	9.0 lbs

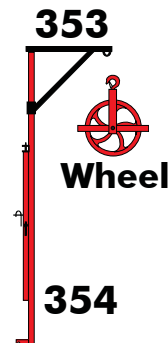

- Scaffolds shall be erected, moved, dismantled, or altered only under the supervision and direction of a competent person qualified in scaffold erection, moving, dismantling or alteration. Such activities shall be performed only by experienced and trained employees selected for such work by the competent person.

Fast Tube (1.9" O.D.)

Part No.	Description	Weight
FT4	4' Fast Tube with End Fittings	13.3 lbs
FT6	6' Fast Tube with End Fittings	18.1 lbs
FT8	8' Fast Tube with End Fittings	23.2 lbs
FT10	10' Fast Tube with End Fittings	27.9 lbs
FT12	12' Fast Tube with End Fittings	32.3 lbs
FT13	13' Fast Tube with End Fittings	35.1 lbs
FT16	16' Fast Tube with End Fittings	42.4 lbs
FT20	20' Fast Tube with End Fittings	55.7 lbs

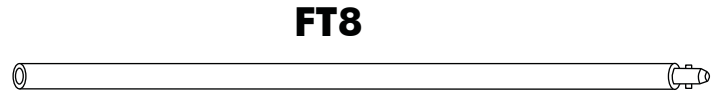

FTBP

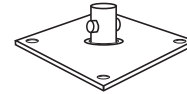

42102

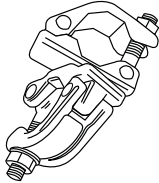

42202

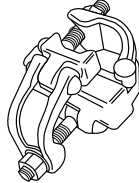

Fits both frames and tubes
- from 1.625 to 1.90 O.D.

Fast Tube Accessories

Part No.	Description	Weight
42102	Dual Swivel Clamp - 1.625" to 1.90" O.D.	4.1 lbs
42202	Dual Rigid Clamp - 1.625" to 1.90" O.D.	3.6 lbs
FTBP	Fixed Base Plate with Stem for Fast Tubes	6.5 lbs

Misc. Accessories

Part No.	Description	Weight
39101	24" Wide Base Stabilizer	14.0 lbs
92100	48" Wide Base Stabilizer	31.5 lbs
47100	Nailing Plate	1.1 lbs
520	Extension Leg	16.0 lbs

47100

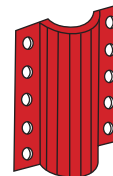

92100

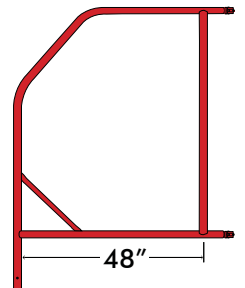

- Questions? Contact us at 1-800-247-9206
- Need more information? Visit our website at www.superiorscaffold.com
- We offer a wide variety of custom solutions for any project. Contact us to discuss your particular needs.

SGRGK

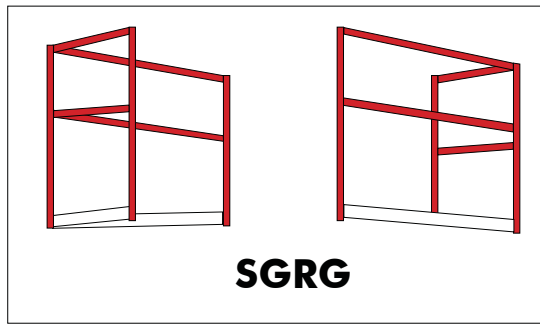

SGRG

SPP6



SPL6

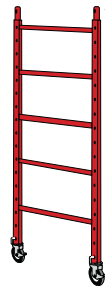

SPT6



SPIC5

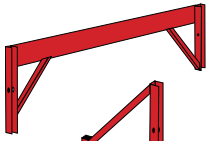

SPS1

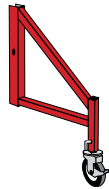

S1260

S660



Decorator/Utility Scaffold & Accessories

Part No.	Description	Weight
S660	6' H X 6' L X 29" W Complete Kit	228.9 lbs
S1260	12' H X 6' L X 29" W Complete Kit	382.1 lbs
SGRGK	Complete Guard Rail Panel Kit	66.1 lbs
SPL6	6' Ladder (End Frame)	24.0 lbs
SGRG	Side & End Guard Rail Panel	33.1 lbs
SPT6	6' Truss	22.5 lbs
SPP6	Platform	36.0 lbs
SPIC5	Caster	3.9 lbs
SPS1	Stabilizer	6.6 lbs

- Current OSHA codes limit the free-standing tower height to 4 times the smallest base dimension. Consult your local, state, and federal codes for compliance.
- Never ride a rolling tower.
- Do not use without guard rail panels and toeboards.
- Use on level, stable surfaces only.

Netting

Part No.	Description
NET1460	Black Netting - U.V. Treated High Density Polyethylene
NET324FR	Black Netting - Fire Retardant Polyethylene Knitted Mesh
NETTIE14	Heavy Duty 14" Cable "Zip" Tie



NET1460 is our strongest, most dense, non-fire retardant netting. It stays flexible even in severe temperatures.

Chutes

Part No.	Description	Weight
CH300	Chute Section with Chains	37.0 lbs
CH301	Intake (Top) Hopper with Chains	63.0 lbs
CH305	Intermediate Hopper with Safety Flap	66.0 lbs
CH310	Basic Support Frame with Hopper Stands	62.0 lbs
CH311	Set of Two Parapet Outriggers	92.0 lbs
CH321	80' Manual Winch with Bar	74.0 lbs

CH301

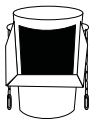

CH300

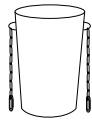

CH305

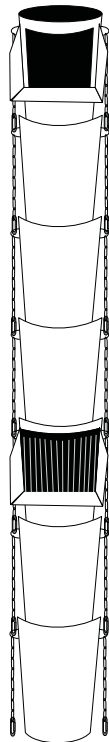

CH311

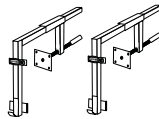

CH310

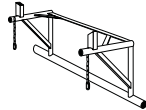

CH321

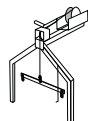

Code of Safe Practices

For Frame Scaffolds, System Scaffolds, Tube and Clamp Scaffolds and Rolling Scaffolds

DEVELOPED FOR INDUSTRY BY SCAFFOLD INDUSTRY ASSOCIATION, INC. (SIA) and THE SCAFFOLD, SHORING & FORMING INSTITUTE (SSFI)

It shall be the responsibility of all users to read and comply with the following common sense guidelines which are designed to promote safety in the erecting, dismantling and use of Scaffolds. These guidelines do not purport to be all-inclusive nor to supplant or replace other additional safety and precautionary measures to cover usual or unusual conditions. If these guidelines in any way conflict with any state, local, provincial, federal or other government statute or regulation, said statute or regulation shall supersede these guidelines and it shall be the responsibility of each user to comply therewith.

I. GENERAL GUIDELINES

- Post these scaffolding safety guidelines in a conspicuous place and be sure that all persons who erect, dismantle or use scaffolding are aware of them, and also use them in tool box safety meetings.
- Follow all state, local and federal codes, ordinances and regulations pertaining to scaffolding.
- Survey the job site. A survey shall be made of the job site by a competent person for hazards, such as untamped earth fills, ditches, debris, high tension wires, unguarded openings, and other hazardous conditions created by other trades. These conditions should be corrected or avoided as noted in the following sections.
- Inspect all equipment before using. Never use any equipment that is damaged or defective in any way. Mark it or tag it as defective. Remove it from the job site.
- Scaffolds must be erected in accordance with design and/or manufacturers' recommendations.
- Do not erect, dismantle or alter a scaffold unless under the supervision of a competent person.
- Do not abuse or misuse the scaffold equipment.
- Erected scaffolds should be continually inspected by users to be sure that they are maintained in safe condition. Report any unsafe condition to your supervisor.
- Never take chances! If in doubt regarding the safety or use of the scaffold, consult your scaffold supplier.
- Never use equipment for purposes or in ways for which it was not intended.
- Do not work on scaffolds if your physical condition is such that you feel dizzy or unsteady in any way.
- Do not work under the influence of alcohol or illegal drugs.

II. GUIDELINES FOR ERECTION AND USE OF SCAFFOLDS

- Scaffold base must be set on an adequate sill or pad to prevent slipping or sinking and fixed thereto where required.
- Any part of a building or structure used to support the scaffold shall be capable of supporting the maximum intended load to be applied.
- Use adjusting screws or other approved methods instead of blocking to adjust to uneven grade conditions.
- Bracing, leveling & plumbing of frame scaffolds -
 1. Plumb and level all scaffolds as the erection proceeds. Do not force frames or braces to fit. Level the scaffold until proper fit can easily be made.
 2. Each frame or panel shall be braced by horizontal bracing, cross bracing, diagonal bracing or any combination thereof for securing vertical members together laterally. All brace connections shall be made secure, in accordance with the manufacturer's recommendations.
- Bracing, leveling & plumbing of tube & clamp and system scaffolds -
 1. Posts shall be erected plumb in all directions, with the first level of runners and bearers positioned as close to the base as feasible. The distance between bearers and runners shall not exceed manufacturer's recommended procedures.
 2. Plumb, level and tie all scaffolds as erection proceeds.
 3. Fasten all couplers and/or connections securely before assembly of next level.
 4. Vertical and/or horizontal diagonal bracing must be installed according to manufacturer's recommendations.
- Tie continuous (running) scaffolds to the wall or structure at each end and at least every 30 feet of length when scaffold height exceeds the maximum allowable free standing dimension. Begin ties or stabilizers when the scaffold height exceeds that dimension, and repeat at vertical intervals not greater than 26 feet. The top anchor shall be placed no lower than four (4) times the base dimension from the top of the completed scaffold. Anchors must prevent scaffold from tipping into or away from wall or structure. Stabilize circular or irregular scaffolds in such a manner that completed scaffold is secure and restrained from tipping. When scaffolds are partially or fully enclosed or subjected to overturning loads, specific precautions shall be taken to insure the frequency and accuracy of ties to the wall and structure. Due to increased loads resulting from wind or overturning loads the scaffolding component to which ties are subjected shall be checked for additional loads.
- When free standing scaffold towers exceed four (4) times their minimum base dimensions vertically, they must be restrained from tipping. (CAL/OSHA and some government agencies require stricter ratio of 3 to 1.)
- Do not erect scaffolds near electrical power lines unless proper precautions are taken. Consult the power service company for advice.
- A means of access to all platforms shall be provided.
- Do not use ladders or makeshift devices on top of scaffolds to increase the height.
- Provide guardrails and mid-rails at each working platform level where open sides and ends exist, and toeboards where required by code.
- Brackets and cantilevered platforms -
 1. Brackets for System Scaffolds shall be installed and used in accordance with manufacturer's recommendations.
 2. Brackets for Frame Scaffolds shall be seated correctly with side bracket parallel to the frames and end brackets at 90 degrees to the frames. Brackets shall not be bent or twisted from normal position. Brackets (except mobile brackets designed to carry materials) are to be used as work platforms only and shall not be used for storage of material or equipment.
 3. Cantilevered platforms shall be designed, installed and used in accordance with manufacturer's recommendations.
- All scaffolding components shall be installed and used in accordance with the manufacturer's recommended procedure.
- Components shall not be altered in the field.

Scaffold frames and their components manufactured by different companies shall not be intermixed, unless the component parts readily fit together and the resulting scaffold's structural integrity is maintained by the user.

- Planking -
 1. Working platforms shall cover scaffold bearer as completely as possible. Only scaffold grade wood planking, or fabricated planking and decking meeting scaffold use requirements shall be used.
 2. Check each plank prior to use to be sure plank is not warped, damaged, or otherwise unsafe.
 3. Planking shall have at least 12" overlap and extend 6" beyond center of support, or be cleated or restrained at both ends to prevent sliding off supports.
 4. Solid sawn lumber, LVL (laminated veneer lumber) or fabricated scaffold planks and platforms (unless cleated or restrained) shall extend over their end supports not less than 6" nor more than 18". This overhang should not be used as a work platform.
- For "putlogs" and "trusses" the following additional guidelines apply:
 1. Do not cantilever or extend putlogs/trusses as side brackets without thorough consideration for loads to be applied.
 2. Putlogs/trusses should be extended at least 6" beyond point of support.
 3. Place recommended bracing between putlogs/trusses when the span of putlog/truss is more than 12 feet.
- For rolling scaffolds the following additional guidelines apply:
 1. Riding a rolling scaffold is very hazardous. The Scaffold Industry Association does not recommend nor encourage this practice. However, if you choose to do so, be sure to follow all state, federal or other governmental guidelines.
 2. Casters with plain stems shall be attached to the panel or adjustment screw by pins or other suitable means.
 3. No more than 12 inches of the screw jack shall extend between the bottom of the adjusting nut and the top of the caster.
 4. Wheels or casters shall be provided with a locking means to prevent caster rotation and scaffold movement and kept locked.
 5. Joints shall be restrained from separation.
 6. Use horizontal diagonal bracing near the bottom and at 20 foot intervals measured from the rolling surface.
 7. Do not use brackets or other platform extensions without compensating for the overturning effect.
 8. The platform height of a rolling scaffold must not exceed four (4) times the smallest base dimension (CAL/OSHA and some government agencies require a stricter ratio of 3 to 1).
 9. Cleat or secure all plank.
 10. Secure or remove all materials and equipment from platform before moving.
 11. Do not attempt to move a rolling scaffold without sufficient help - watch out for holes in floor and overhead obstructions - stabilize against tipping.
- Safe use of scaffold -
 1. Prior to use, inspect scaffold to insure it has not been altered and is in safe working condition.
 2. Erected scaffolds and platforms should be inspected continuously by those using them.
 3. Exercise caution when entering or leaving a work platform.
 4. Do not overload scaffold. Follow manufacturer's safe working load recommendations.
 5. Do not jump onto planks or platforms.
 6. Do not use ladders or makeshift devices on top of working platforms to increase the height or provide access from above.
 7. Climb in access areas only and use both hands.

III. WHEN DISMANTLING SCAFFOLDING THE FOLLOWING ADDITIONAL GUIDELINES APPLY:

- Check to assure scaffolding has not been structurally altered in a way which would make it unsafe and, if it has, reconstruct where necessary before commencing with dismantling procedures. This includes all scaffold ties.
- Visually inspect plank prior to dismantling to be sure they are safe.
- Consideration must be given as to the effect removal of a component will have on the rest of the scaffold prior to that component's removal.
- Do not accumulate excess components or equipment on the level being dismantled.
- Do not remove ties until scaffold above has been removed (dismantled).
- Lower dismantled components in an orderly manner. Do not throw off of scaffold.
- Dismantled equipment should be stockpiled in an orderly manner.
- FOLLOW ERECTION PROCEDURES AND USE MANUALS.
- These safety guidelines (Codes of Safe Practice) set forth common sense procedures for safely erecting, dismantling and using scaffolding equipment. However, equipment and scaffolding systems differ, and accordingly, reference must always be made to the instructions and procedures of the supplier and/or manufacturer of the equipment.
- Since field conditions vary and are beyond the control of the
- Scaffold Industry Association, safe and proper use of scaffolding is the sole responsibility of the user.





Building on a solid foundation

In addition to scaffolding systems, Superior specializes in the sale, rental, service and installation of suspended scaffolds, mast climbing platforms, sidewalk bridges, rolling towers, shoring, fall protection systems, safety training, debris chutes and netting.

Client demand has led us into many new arenas, such as mast climbers, man/material hoists and negative pressure wrap enclosures. We are constantly looking for ways to provide a more complete and convenient service to our clients.

See why we are Superior!

Learn more about our other products in these catalogs

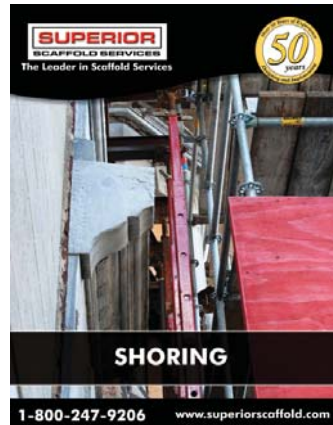
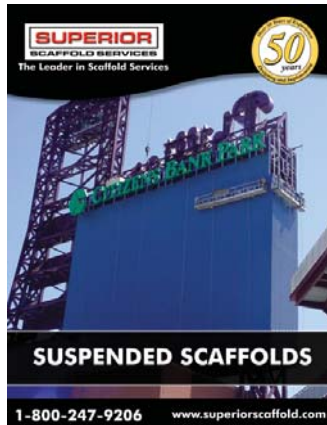
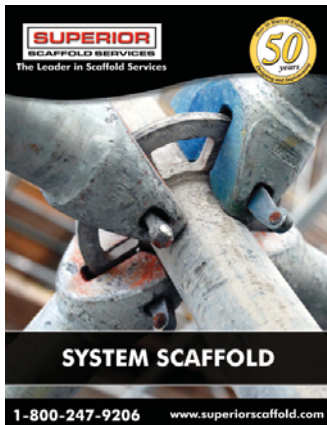

Visit our website to get more information about Superior Scaffold Services and the products we offer.

Superior Scaffold Services | 520 East Luzerne Street | Philadelphia, PA 19124

1-800-247-9206

www.superiorscaffold.com